



## BCMA Series

### Common Mode Filters For Automotive Power Line

#### Size 7060

#### FEATURES

- Exclusive square type closed magnetic core designed as an exclusive core is used, so it can be small while maintaining the same features.
- Low profile design makes it optimal for surface mounting.
- Excellent impedance characteristics, making it great for suppressing common mode noise.
- Maximum 15A can be used in 125°C environments.
- Operating temperature range: -40 to +125°C
- AEC-Q200 qualified
- Quantity: 1500pcs

#### APPLICATIONS

- Measures against common mode noise in power lines for various DC power lines, multimedia devices, and various electronic devices

#### Dimensions: [mm]

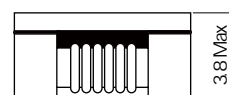
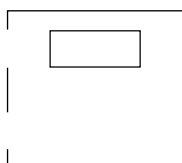
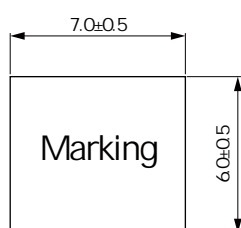

#### Land Pattern: [mm]

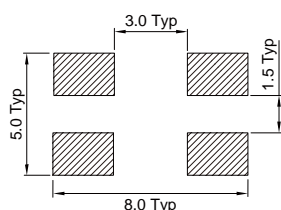

#### Electrical Properties:

Part No	Z @ 100 MHz Min. ( $\Omega$ )	Z @ 100 MHz Typ. ( $\Omega$ )	I <sub>R</sub> Max. (A)	R <sub>DC</sub> Max. (m $\Omega$ )	V <sub>DC</sub> Max. (Volts)	IR Min. (M $\Omega$ )
BCMA7060-700Y	40	70	15	5	80	10
BCMA7060-141Y	100	140	9.0	10	80	10
BCMA7060-301Y	225	300	5.0	10	80	10
BCMA7060-501Y	400	500	5.0	10	80	10
BCMA7060-701Y	500	700	4.0	15	80	10
BCMA7060-102Y	800	1000	3.0	17	80	10
BCMA7060-132Y	910	1300	3.0	20	80	10
BCMA7060-272Y	2000	2700	1.0	63	80	10
BCMA7060-302Y	2500	3000	0.9	75	80	10



## Typical Electrical Characteristics:

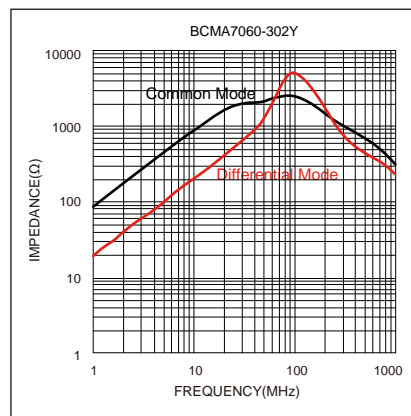
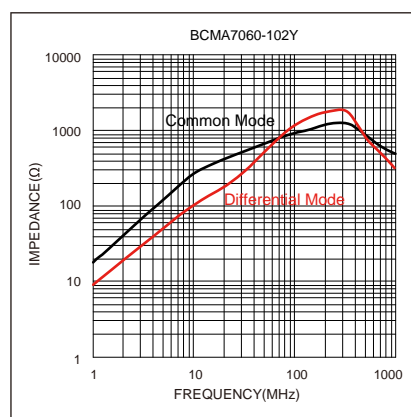
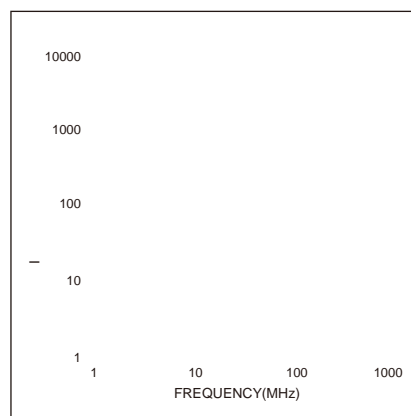
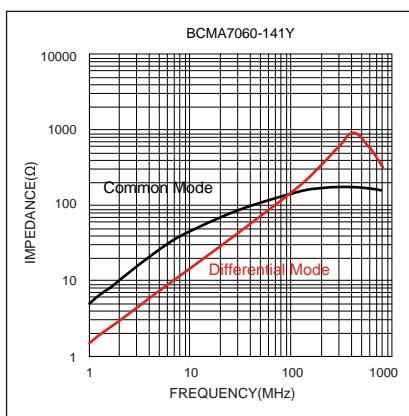
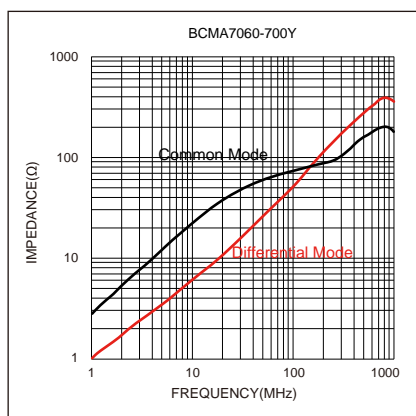



## Soldering Reflow:

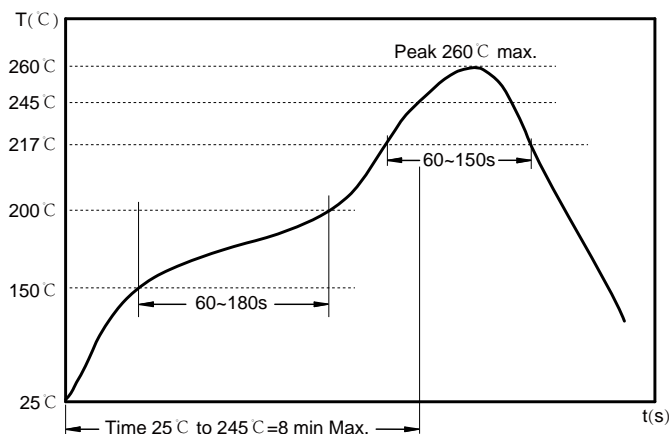

Preheat condition: 150 ~200 °C / 60~180 sec.

Allowed time above 217 °C: 60~150 sec.

Max temperature: 260 °C.

Max time at max temperature: 10 sec.

Allowed Reflow time: 3x max.

## Packaging Information:

### Tape Dimension:

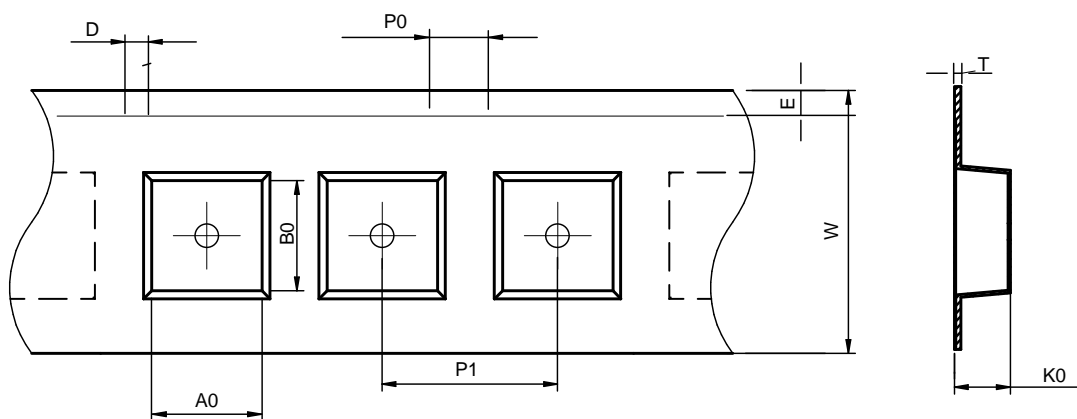

Series	A0 (mm)	B0 (mm)	D (mm)	P0 (mm)	P1 (mm)	W (mm)	K0 (mm)	E (mm)	T (mm)
45? 3) ("	( \$' f " z#	) 2) f " z#	# 2 f " z#	& 2 f " z#	# \$ 2 f " z#	# ( 2 f " 2%	% ( f " z#	# 2) ' f " z#	" z& " f " z' "

### Product Marking:

? Sd] [ Y	Bd[ f[ Y ;_ bWWS' UW'i
-----------	------------------------



165°-180°

Top cover tape



Base tape



## Cautions and Warnings:

### Storage Conditions:

- The storage period is within 12 months after the completion of production. Be sure to follow the storage conditions (temperature: -5 to 35°C, humidity: 75% RH Max). If the storage period elapses, the soldering of the terminal electrodes may deteriorate. The warranty period is one year.
- Product should not be exposed to environment with high temperature, high humidity, dust, corrosive gas and etc.
- Products should be handled with care to avoid damage or contamination from perspiration and skin oils.
- Please always handle products carefully to prevent any damage caused by dropping down or inappropriate removing.

### Operation Instructions:

- Self heating (temperature increase) occurs when the power is turned ON, so the tolerance should be sufficient for the set thermal design.
- Before soldering, be sure to preheat components. The preheating temperature should be set so that the temperature difference between the solder temperature and chip temperature does not exceed 150°C.
- Soldering corrections after mounting should be within the range of the conditions determined in the specifications. If overheated, a short circuit, performance deterioration, or lifespan shortening may occur.
- Generally, Koher might not be familiar with either customer's specific application or actual requests as customer does. As a result customer shall be responsible for checking and confirming whether Koher product with the performance described in the product specification is suitable for using in customer's particular application or not.

### Conformal coating:

- The inductance value may change due to the high cure stress of the resin used for coating or molding.
- An open circuit may occur due to mechanical stress from the resin, its amount, cured shape, or operating conditions.
- Please exercise careful attention when selecting a resin for the coating or molding process.
- Prior to using the coating resin, please verify that no reliability issues are observed.
- When applying conformal coating for product protection, materials with a high shrinkage rate should be avoided. If such materials must be used, it is recommended to apply silicone around the inductor core in a closed loop to prevent the conformal coating from flowing into or penetrating the windings, thereby avoiding open-circuit failures caused by the coating's thermal stress.